

Schütte HSK50 // Shaft $\varnothing 20$ mm // RS $\varnothing 35$ mm

For Schütte tool grinding machines with ring set $\varnothing 35$ mm
Series 205

GWA HSK50 // $\varnothing 20$ mm // RS $\varnothing 35$ mm

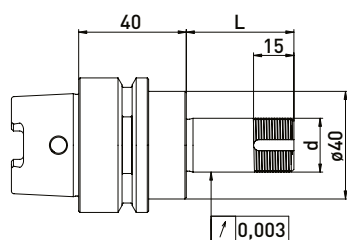
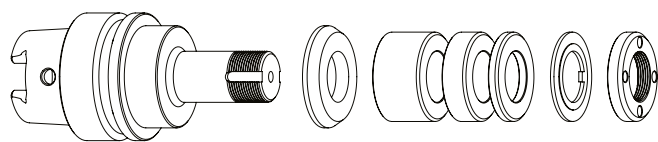

Delivered equipped:
 Reducing washer, ring set $\varnothing 35$ mm, lock washer and clamping nut

Ring set $\varnothing 35$ mm

Order No.	HSK	d	L	B 20	B 10	B 4
300012512	HSK50	20	40	-	1	3
300012522	HSK50	20	60	1	1	3
300012532	HSK50	20	75	1	2	4
300012542	HSK50	20	85	2	1	4
300012552	HSK50	20	100	2	3	3

GWA HSK50 // $\varnothing 20$ mm // without RS

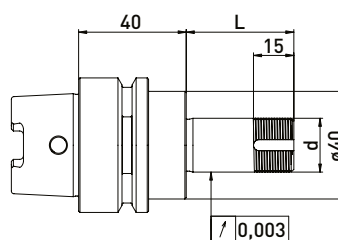
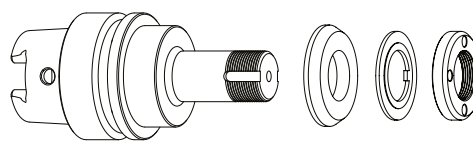

Delivered equipped:
 Reducing washer, lock washer and clamping nut

Order No.	HSK	d	L
300012511	HSK50	20	40
300012521	HSK50	20	60
300012531	HSK50	20	75
300012541	HSK50	20	85
300012551	HSK50	20	100

Accessories Schütte grinding wheel adapter HSK50 // Shaft $\varnothing 20$ mm // Ring set $\varnothing 35$ mm

Order No.	Name	
350050010	Universal assembly device $\varnothing 50$	
350040010	Clamping nut wrench PC27 for $\varnothing 20$	
350040011	Clamping nut wrench PC27 for $\varnothing 20$	
350040040	*Clamping nut wrench PC29 for $\varnothing 20$ for clamping nut with blancing option	
350040041	*Spannmutterschlüssel TK29 für $\varnothing 20$	
350020081	*Balancing weight pair for clamping nut $\varnothing 35$ // 40gmm	

Order No.	Name	
350012020	Spacer ring $\varnothing 35 \times \varnothing 20 \times 20$	
350012010	Spacer ring $\varnothing 35 \times \varnothing 20 \times 10$	
350012004	Spacer ring $\varnothing 35 \times \varnothing 20 \times 4$	
350015006	Reducing washer $\varnothing 40 \times \varnothing 35 \times \varnothing 20 \times 6$	
350030020	Lock washer $\varnothing 35 \times \varnothing 20 \times 2$	
350020030	Clamping nut $\varnothing 35 \times 6$ M20 x 1 PC27	
350020080	*Clamping nut with blancing option $\varnothing 35 \times \varnothing 40 \times 8 \times$ M20 x 1 PC29	
350015005	Support washer $\varnothing 35 \times \varnothing 60 \times \varnothing 20 \times 6$	

Schütte HSK50 // Shaft $\varnothing 20$ mm // RS $\varnothing 50$ mm

For Schütte tool grinding machines with ring set $\varnothing 50$ mm
Series 205

GWA HSK50 // $\varnothing 20$ mm // RS $\varnothing 50$ mm

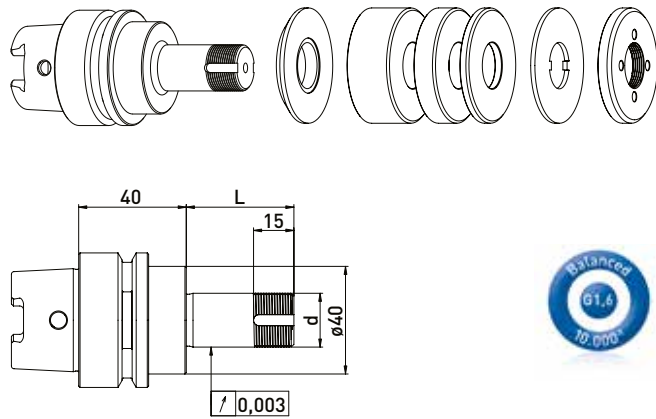

Delivered equipped:
 Ring set $\varnothing 50$ mm, lock washer and clamping nut

Order No.	HSK	d	L	Ring set $\varnothing 50$ mm		
				B 20	B 10	B 4
300012012	HSK50	20	40	-	1	3
300012022	HSK50	20	60	1	1	3
300012032	HSK50	20	75	1	2	4
300012042	HSK50	20	85	2	1	4
300012052	HSK50	20	100	2	3	3

GWA HSK50 // $\varnothing 20$ mm // without RS

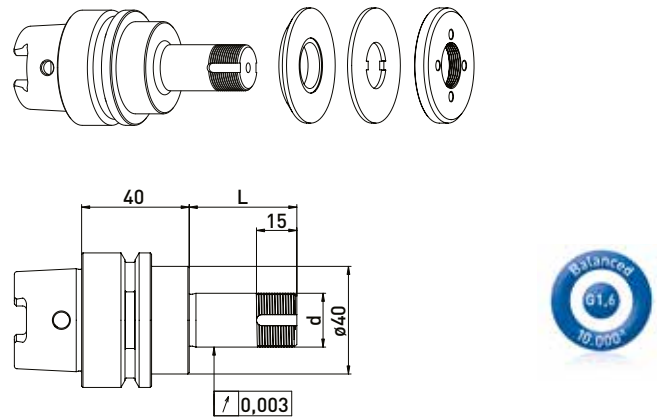

Delivered equipped:
 Lock washer and clamping nut

Order No.	HSK	d	L
300012011	HSK50	20	40
300012021	HSK50	20	60
300012031	HSK50	20	75
300012041	HSK50	20	85
300012051	HSK50	20	100

Accessories Schütte grinding wheel adapter HSK50 // Shaft $\varnothing 20$ mm // Ring set $\varnothing 50$ mm

Order No.	Name	
350050010	Universal assembly device $\varnothing 50$	
350040010	Clamping nut wrench PC27 for $\varnothing 20$	
350040011	Clamping nut wrench PC27 for $\varnothing 20$	
350020021	*Balancing weight pair for clamping nut $\varnothing 50$ // 100gmm	

Order No.	Name	
350011020	Spacer ring $\varnothing 50 \times \varnothing 20 \times 20$	
350011010	Spacer ring $\varnothing 50 \times \varnothing 20 \times 10$	
350011004	Spacer ring $\varnothing 50 \times \varnothing 20 \times 4$	
350030010	Lock washer $\varnothing 50 \times \varnothing 20 \times 2$	
350020060	Clamping nut $\varnothing 50 \times 6 \times M20 \times 1$ PC27	
350020020	*Clamping nut with balancing option $\varnothing 50 \times 8,5 M20 \times 1,0$ PC27	
350015002	Reducing washer $\varnothing 40 \times \varnothing 50 \times \varnothing 20 \times 6$	

*related items

Schütte HSK-E50 // Shaft $\varnothing 20$ mm // RS $\varnothing 35$ mm

For Schütte tool grinding machines with ring set $\varnothing 35$ mm
Series 305

GWA HSK-E50 // $\varnothing 20$ mm // RS $\varnothing 35$ mm

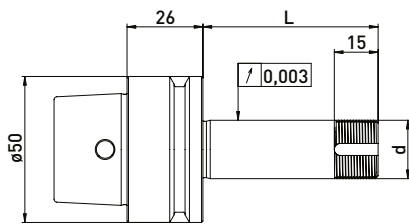
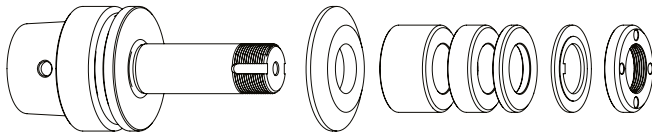

Delivered equipped:

Reducing washer, ring set $\varnothing 35$ mm, lock washer and clamping nut

Ring set $\varnothing 35$ mm

Order No.	HSK	d	L	B 20	B 10	B 4
300052512	HSK-E50	20	40	-	1	3
300052522	HSK-E50	20	60	1	1	3
300052532	HSK-E50	20	85	2	1	4

GWA HSK-E50 // $\varnothing 20$ mm // without RS

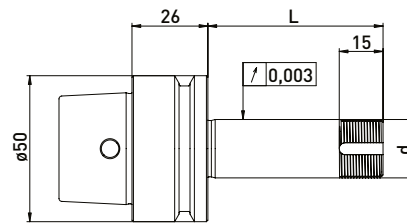
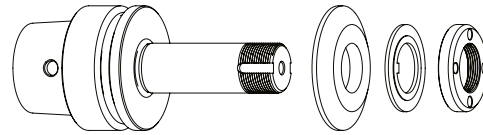

Delivered equipped:

Reducing washer, lock washer and clamping nut

Order No.	HSK	d	L
300052511	HSK-E50	20	40
300052521	HSK-E50	20	60
300052531	HSK-E50	20	85

Accessories Schütte grinding wheel adapter HSK-E50 // Shaft $\varnothing 20$ mm // Ring set $\varnothing 35$ mm

Order No.	Name	
350050010	Universal assembly device $\varnothing 50$	
350040010	Clamping nut wrench PC27 for $\varnothing 20$	
350040011	Clamping nut wrench PC27 for $\varnothing 20$	
350040040	*Clamping nut wrench PC29 for $\varnothing 20$ for clamping nut with blancing option	
350040041	*Spannmutterschlüssel TK29 für $\varnothing 20$	
350020081	*Balancing weight pair for clamping nut $\varnothing 35$ // 40gmm	

Order No.	Name	
350012020	Spacer ring $\varnothing 35 \times \varnothing 20 \times 20$	
350012010	Spacer ring $\varnothing 35 \times \varnothing 20 \times 10$	
350012004	Spacer ring $\varnothing 35 \times \varnothing 20 \times 4$	
350015001	Reducing washer $\varnothing 50 \times \varnothing 35 \times \varnothing 20 \times 6$	
350030020	Lock washer $\varnothing 35 \times \varnothing 20 \times 2$	
350020030	Clamping nut $\varnothing 35 \times 6$ M20 x 1 PC27	
350020080	*Clamping nut with balancing option $\varnothing 35 \times \varnothing 40 \times 8$ x M20 x 1 PC29	
350015005	Support washer $\varnothing 35 \times \varnothing 60 \times \varnothing 20 \times 6$	

Schütte HSK-E50 // Shaft $\varnothing 20$ mm // RS $\varnothing 50$ mm

For Schütte tool grinding machines with ring set $\varnothing 50$ mm
Series 305

GWA HSK-E50 // $\varnothing 20$ mm // RS $\varnothing 50$ mm

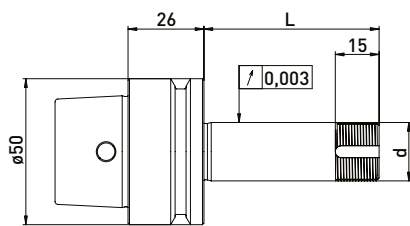
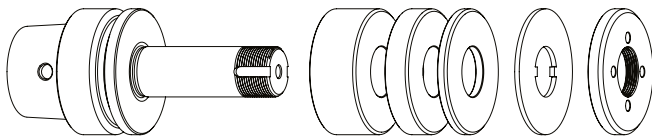

Delivered equipped:
 Ring set $\varnothing 50$ mm, lock washer and clamping nut

Order No.	HSK	d	L	Ring set $\varnothing 50$ mm		
				B 20	B 10	B 4
300052012	HSK-E50	20	40	-	1	4
300052022	HSK-E50	20	60	1	1	4
300052032	HSK-E50	20	85	2	2	3

GWA HSK-E50 // $\varnothing 20$ mm // without RS

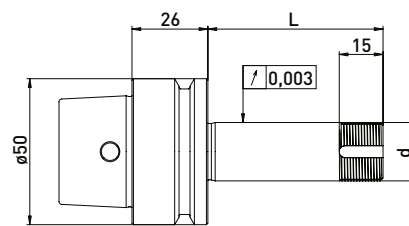
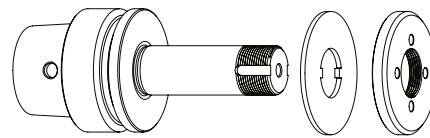

Delivered equipped:
 Lock washer and clamping nut

Order No.	HSK	d	L
300052011	HSK-E50	20	40
300052021	HSK-E50	20	60
300052031	HSK-E50	20	85

Accessories Schütte grinding wheel adapter HSK-E50 // Shaft $\varnothing 20$ mm // Ring set $\varnothing 50$ mm

Order No.	Name	
350050010	Universal assembly device $\varnothing 50$	
350040010	Clamping nut wrench PC27 for $\varnothing 20$	
350040011	Clamping nut wrench PC27 for $\varnothing 20$	
350020021	*Balancing weight pair for clamping nut $\varnothing 50$ // 100gmm	

Order No.	Name	
350011020	Spacer ring $\varnothing 50 \times \varnothing 20 \times 20$	
350011010	Spacer ring $\varnothing 50 \times \varnothing 20 \times 10$	
350011004	Spacer ring $\varnothing 50 \times \varnothing 20 \times 4$	
350030010	Lock washer $\varnothing 50 \times \varnothing 20 \times 2$	
350020060	Clamping nut $\varnothing 50 \times 6 \times M20 \times 1$ PC27	
350020020	*Clamping nut with balancing option $\varnothing 50 \times 8,5 M20 \times 1,0$ PC27	

*related items